

The logo for gio, featuring the word "gio" in a lowercase, sans-serif font, with a small white dot to the right of the "o".

# gio.

## USER MANUAL

**BG** Ръководство за употреба / **CS** Uživatelský manuál  
**DE** Benutzerhandbuch / **DK** Brugermanual / **EE** Kasutusjuhend  
**ES** Manual de usuario / **FI** Ohjekirja / **FR** Manuel de l'Utilisateur  
**GR** Εγχειρίδιο χρήστη / **HR** Korisnički priručnik  
**HU** Használati utasítás / **IS** Leiðarvísir / **IT** Manuale d'uso  
**LT** Vartotojo vadovas / **LV** Lietotāja rokasgrāmata  
**MT** Manwal għall-utent / **NL** Handleiding / **NOR** Brukermanual  
**PL** Instrukcja obsługi / **PT** Manual do usuário  
**RO** Manual de utilizare / **RU** Руководство пользователя  
**SE** Användarmanual / **SK** Používateľská príručka  
**SL** Navodila za uporabo / **TR** Kullanım kılavuzu  
**UA** Посібник користувача

Video guide:



# INSIDE THE BOX

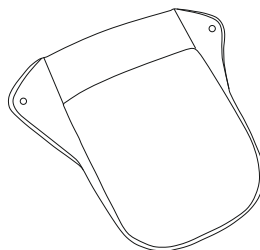
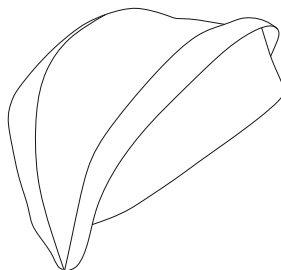
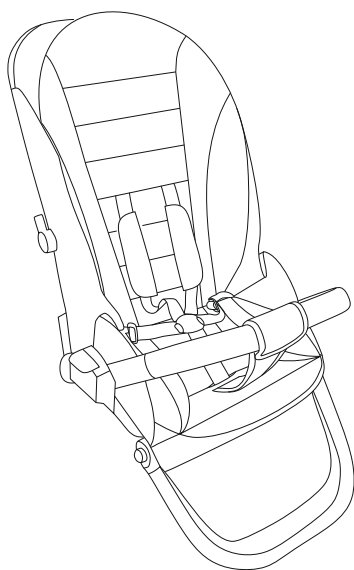
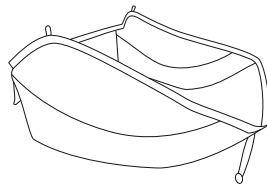
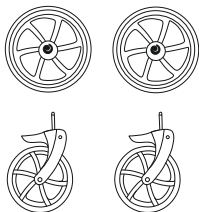
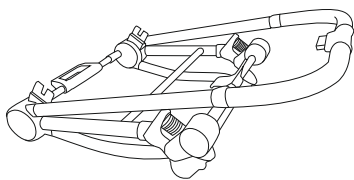

# CHASSIS

## SET-UP

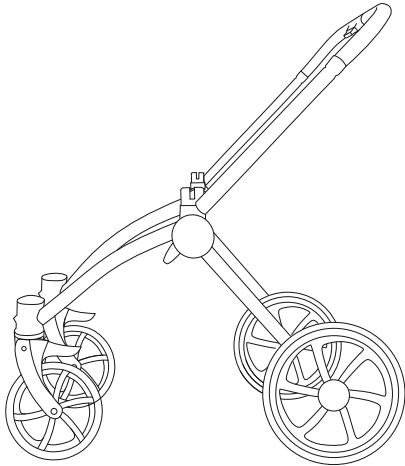
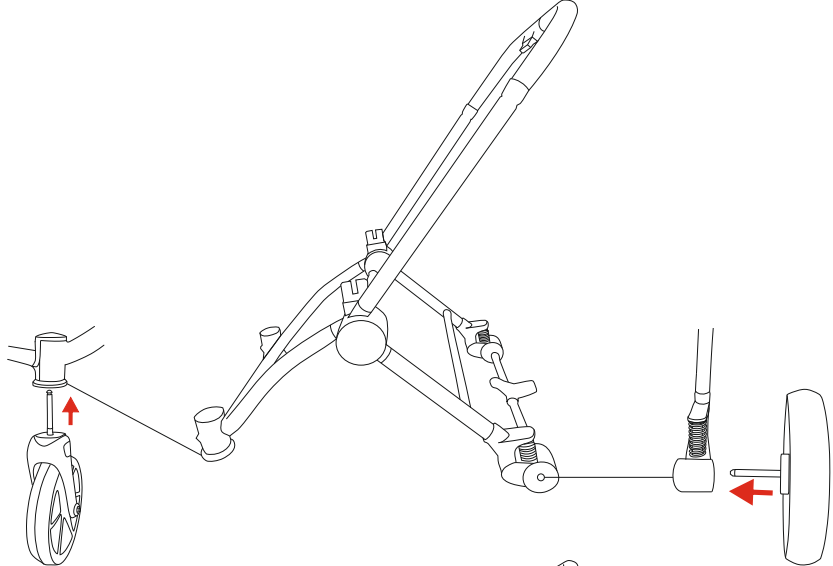
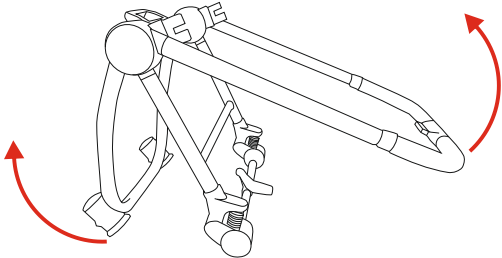
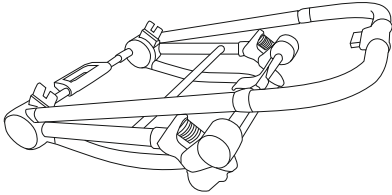

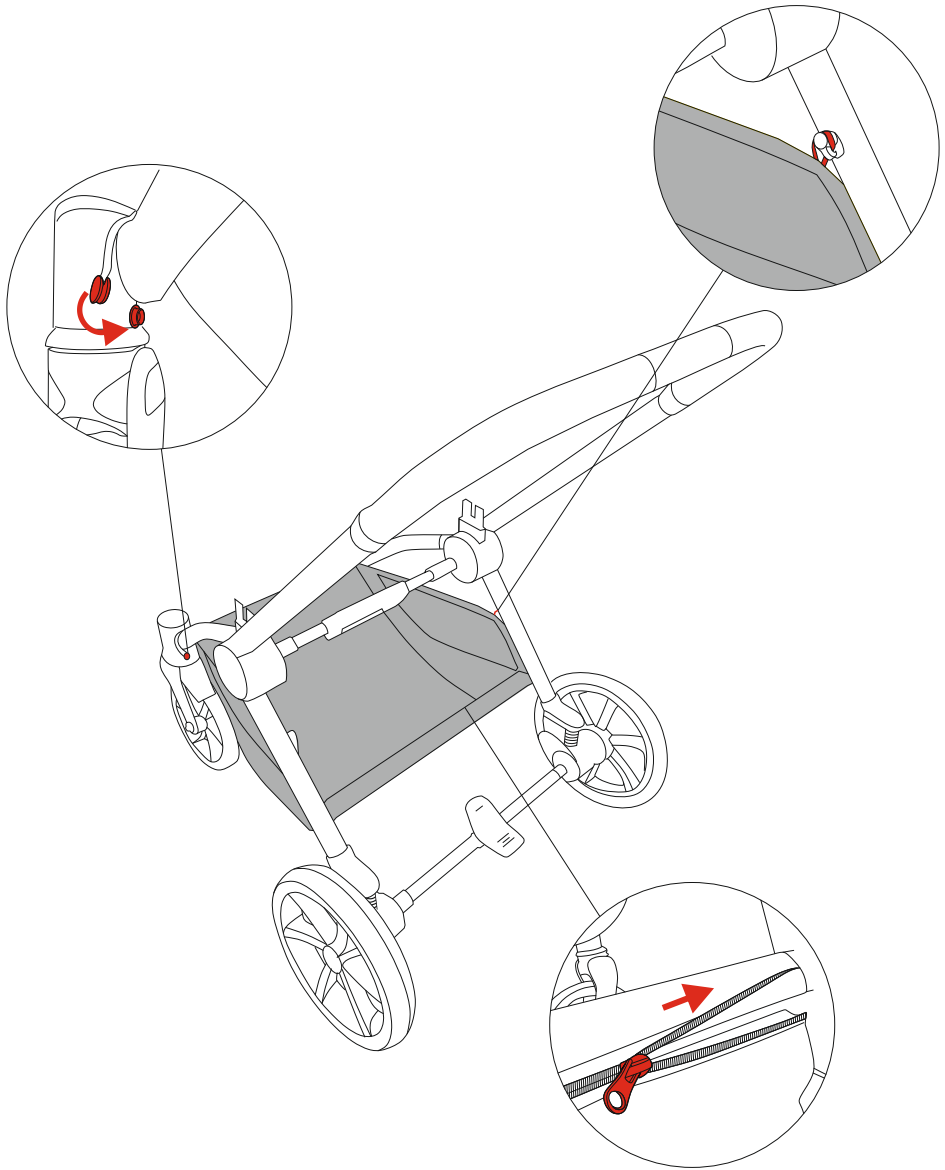

# FUNCTIONS

---

## Wheels

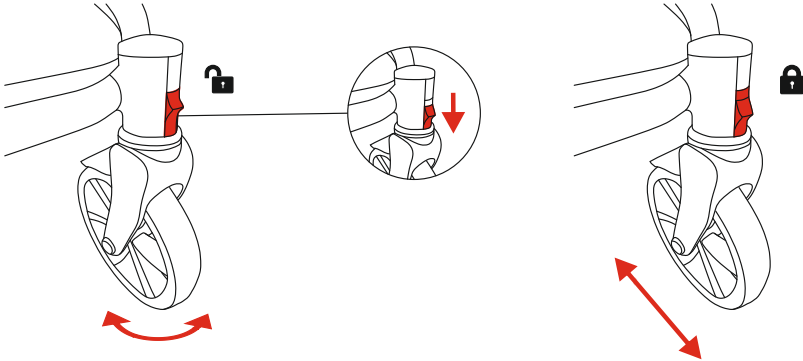

---

## Telescopic handle

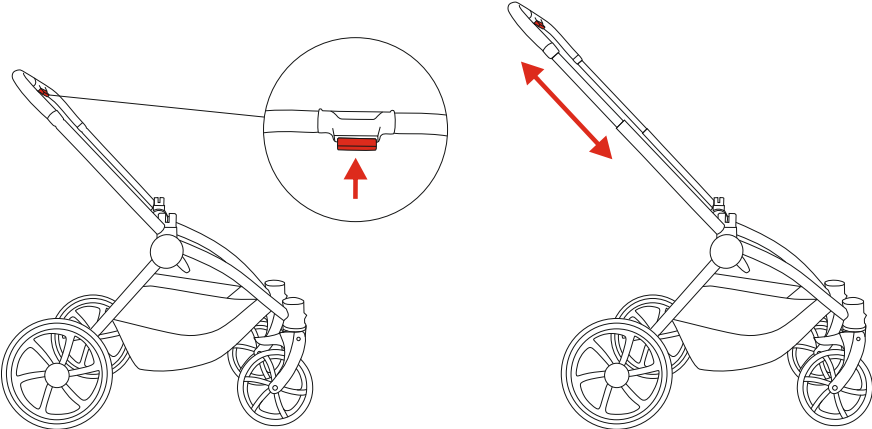

---

## Parking brake

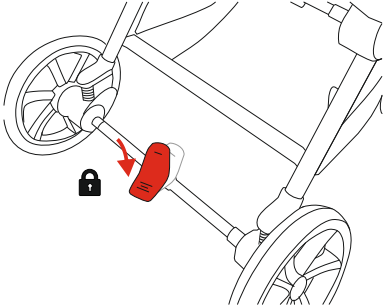

# CHASSIS FOLDING

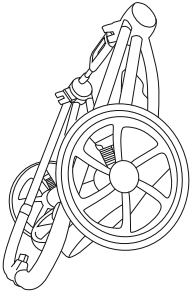
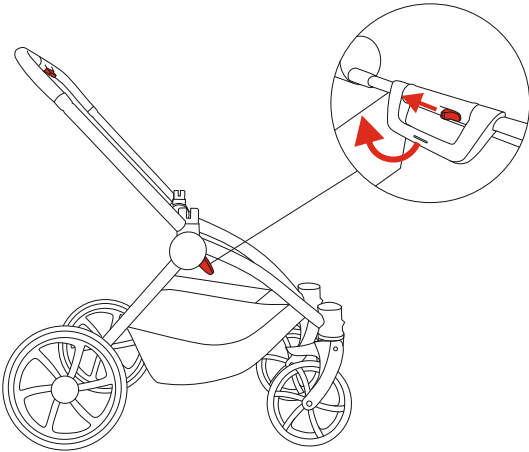
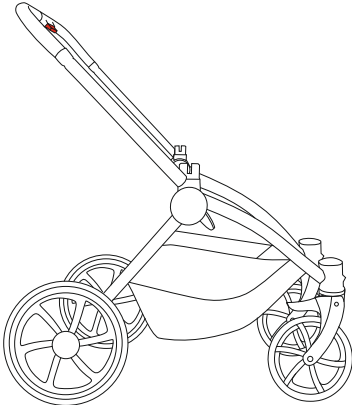
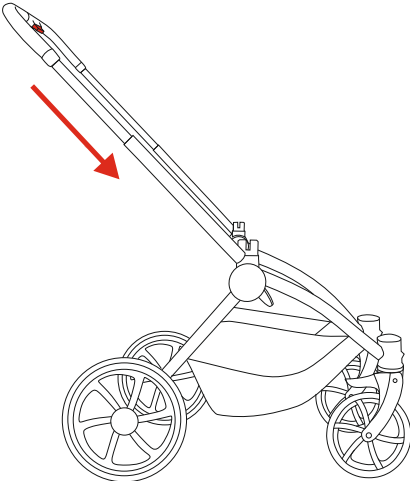

# SEAT UNIT



## SET-UP

Canopy

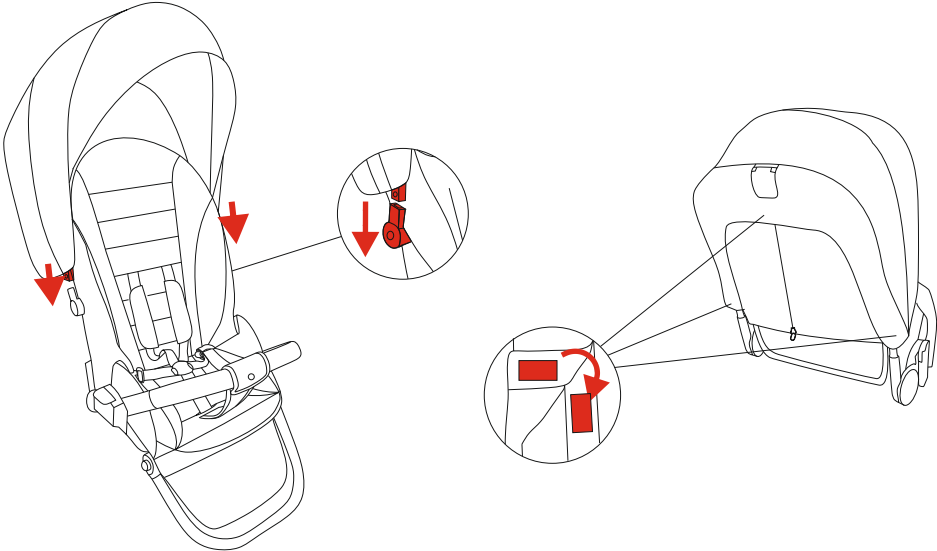

## FUNCTIONS

Bumper bar

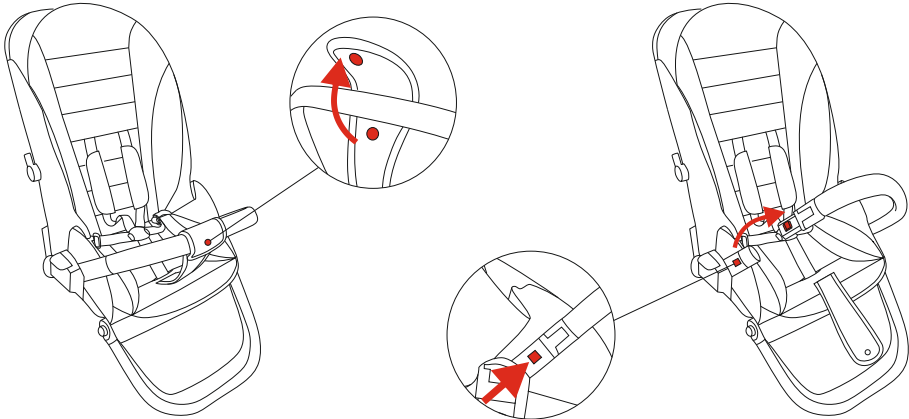



Harness

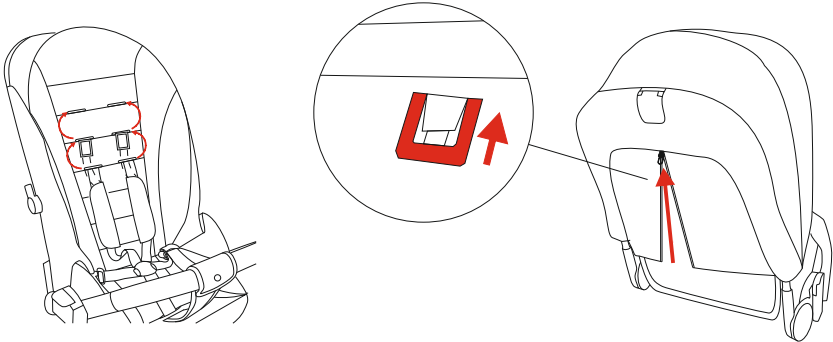

---

Footrest

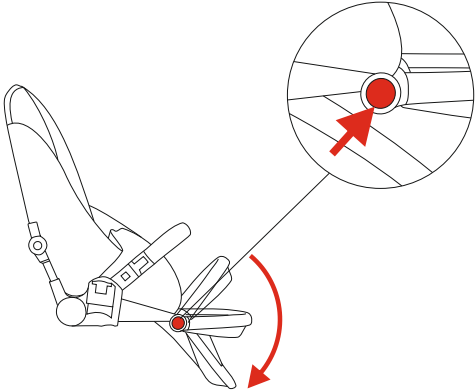

---

Buckle

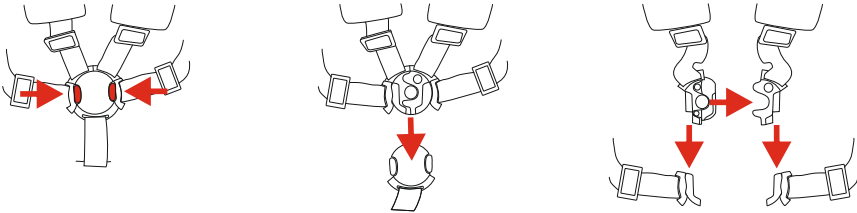

## Ventilation

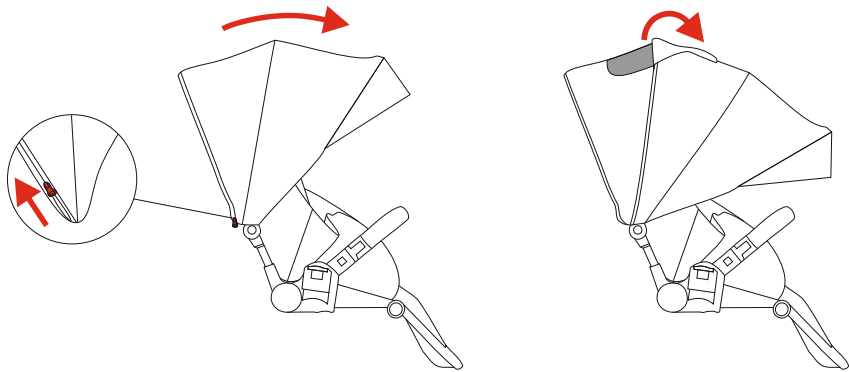

---

## Foot cover

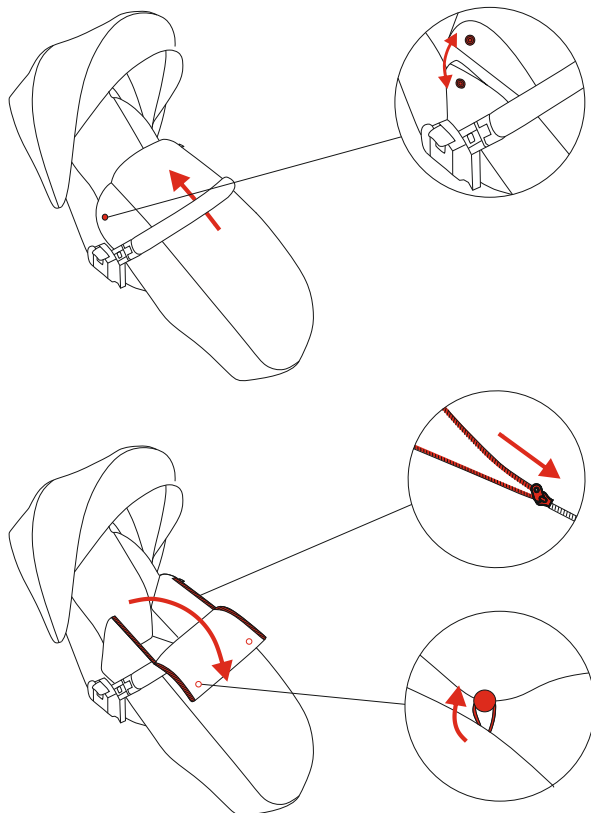

Backrest

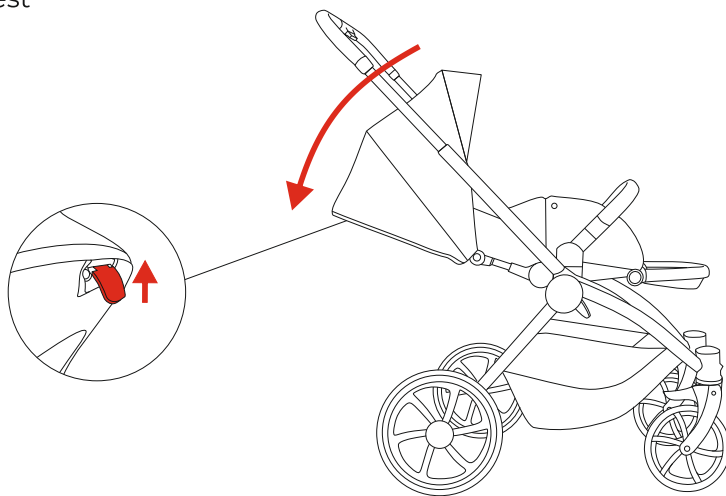

---

## INSERT AND REMOVE SEAT

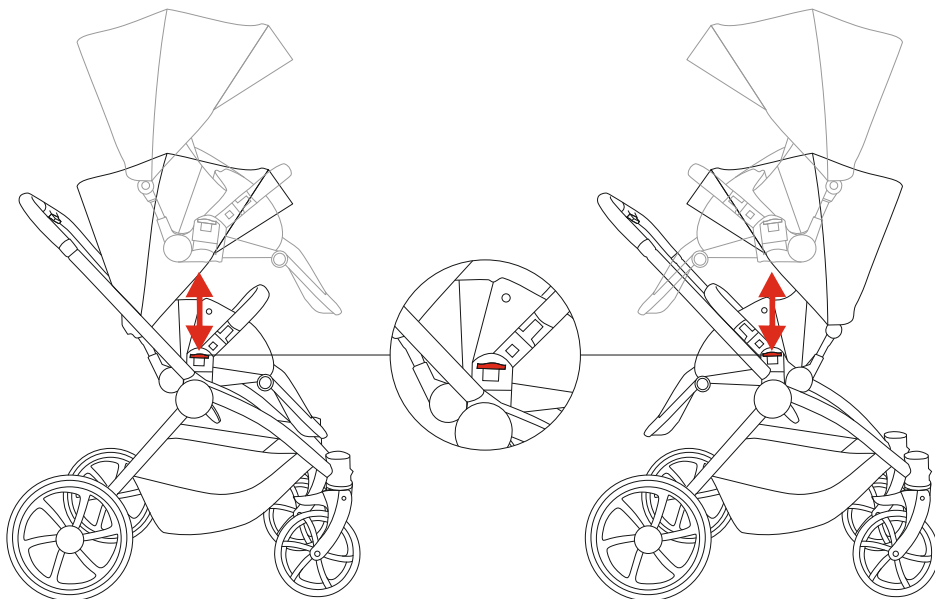

# FOLDING WITH SEAT UNIT 1

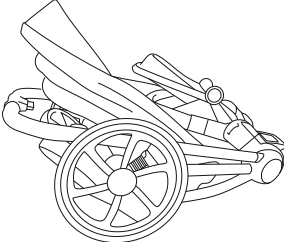
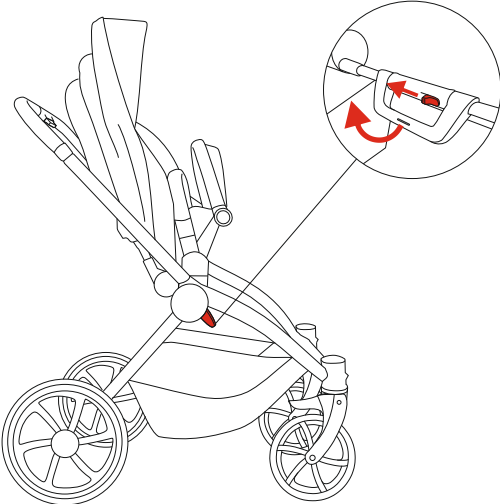
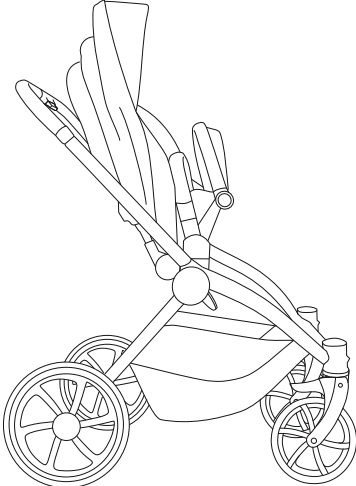
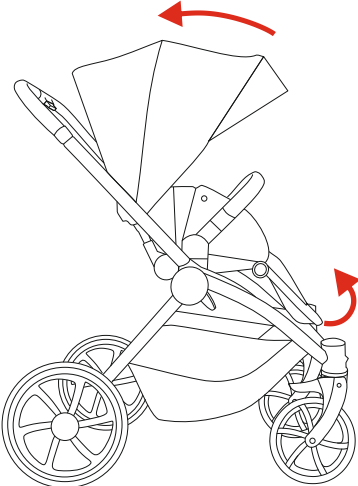

# FOLDING WITH SEAT UNIT 2

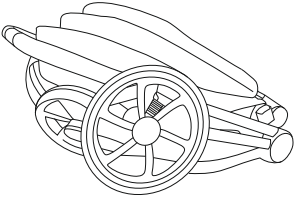
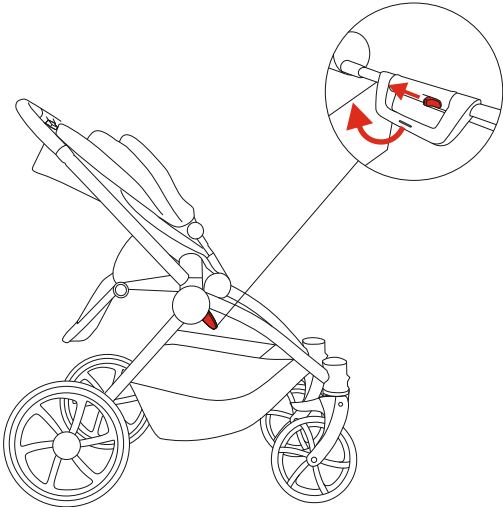
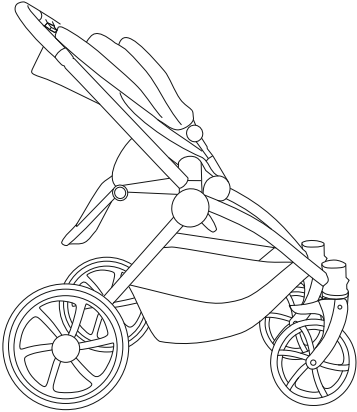
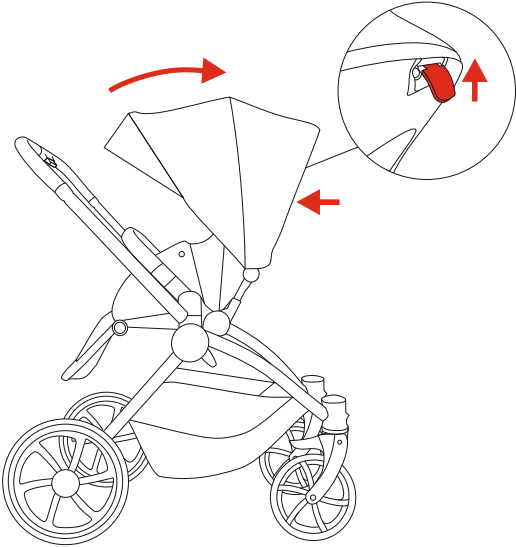

# ACCESSORIES

Car seat adapters

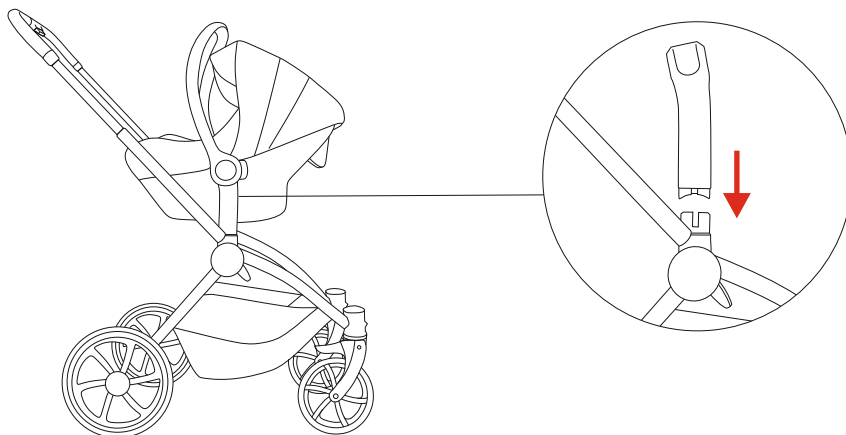

# SERVICE AND MAINTENANCE RECORD

Date	Description	Signature

Date of purchase: ..... Warranty period: .....

Seller: .....

**For more information**  
<https://service.tutis.lt/>  
E-mail: [support@tututis.lt](mailto:support@tututis.lt)

**CK4159 240527 Rev. A**





